

“The Application of Japanese Candlestick Trading Strategies in Taiwan”

AUTHORS	Yeong-Jia Goo Dar-Hsin Chen Yi-Wei Chang
ARTICLE INFO	Yeong-Jia Goo, Dar-Hsin Chen and Yi-Wei Chang (2007). The Application of Japanese Candlestick Trading Strategies in Taiwan. <i>Investment Management and Financial Innovations</i> , 4(4)
RELEASED ON	Wednesday, 12 December 2007
JOURNAL	"Investment Management and Financial Innovations"
FOUNDER	LLC “Consulting Publishing Company “Business Perspectives”



NUMBER OF REFERENCES

0



NUMBER OF FIGURES

0



NUMBER OF TABLES

0

© The author(s) 2025. This publication is an open access article.

THE APPLICATION OF JAPANESE CANDLESTICK TRADING STRATEGIES IN TAIWAN

Yeong-Jia Goo^{*}, Dar-Hsin Chen^{**}, Yi-Wei Chang^{***}

Abstract

The Japanese candlestick is one of the most popular technical methods used to predict future price trends based on the relationships among opening, high, low, and closing prices. By using the daily data of 25 component stocks in the Taiwan Top 50 Tracker Fund and Taiwan Mid-Cap 100 Tracker Fund from 1997 to 2006, this study tries to explore which candlesticks can be used by investors and how many holding days will be profitable for each of them. The t-tests are applied to test the profitability of the candlesticks, and ANOVA and Duncan's multiple range test are then used to examine and compare the profitability of candlesticks and holding days. Furthermore, this study also tries to implement a stop loss strategy to improve the performance of candlesticks. The research findings provide strong evidence that some of the candlestick trading strategies do have value for investors and different candlestick needs different holding days. Meanwhile, the performance of the most candlesticks has been improved with stop loss strategy.

Key words: candlestick trading strategy, technical analysis, general linear model, ANOVA, Duncan's multiple range test.

JEL Classification: G12, G14.

1. Introduction

In the technical analysis area, the Japanese candlestick technique has become one of the most popular methods used to predict future price trends. Its magic power has been widely discussed and frequently used by investors both in Asian and western countries. In the eastern countries, the technique was first applied in the Japanese rice market in the 1600s and was then used by Japanese traders in financial markets as they developed. The candlestick technique was not discovered by the western world until 1991 when Steven Nison published the first book on the candlestick technique in English (Nison, 1991). By using the relationships among the opening, high, low and closing prices within a day and over consecutive days, this method reflects the psychology in the market and generates buy and sell signals. In this way, investors can formulate suitable trading strategies to make money.

Although the argument revolving around the concept of market efficiency will never be resolved, there is no doubt that technical analysis has become ubiquitous, and is available in almost every software and online charting package (Nison, 2003, p. 22). In Taiwan, it is very common for investors to use many kinds of technical indicators, such as candlesticks, moving averages (MA), moving average convergence divergence (MACD), and relative strength indices (RSI), etc. to make investment decisions. In particular, in the case of candlesticks, investors prefer to adopt this indicator because it can reflect information better than other indicators. By using the information based on the four prices, the candlestick can not only reveal the psychology of other investors but also the demand and supply forces in the market. Therefore, the candlestick technique has become a basic investment tool in Taiwan and every investor knows at least a little about it. Besides, the candlestick was not introduced to the western countries until 1991, and this technique has now become a major focus of western investors because of its magic power. Traditionally, the value of technical analysis has been ignored by academic research. However, there have been more and more studies in the academic world examined the profitability and usability of using candlestick techniques recently.

^{*} National Taipei University, Taiwan.

^{**} National Taipei University, Taiwan.

^{***} National Taipei University, Taiwan.

By using the daily data for the 25 component stocks in the Taiwan Top 50 Tracker Fund and Taiwan Mid-Cap 100 Tracker Fund over the 1997-2006 period, this study separates holding days through one to ten and accounts for the rate of return day by day. The t-tests are applied to test the profitability of the candlesticks, and the ANOVA and Duncan's multiple range test are then used to discuss and compare the profitability of candlesticks on each holding day and the profitability of holding days for each candlestick. Meanwhile, this study also tries to implement a stop loss strategy to improve the performance of candlesticks. The research findings provide strong evidence that some of the candlestick trading strategies do have valuable value for investors and that different candlestick needs different holding periods. Besides, the performance of the most candlesticks has been improved with stop loss strategy. Finally, by following the findings of the study, investors will know how to apply each candlestick type properly and it will help them to improve their investment performance.

The remainder of this study is organized as follows. Section 2 describes the technical analysis, history of candlesticks, candlestick charting and former studies regarding candlestick techniques. Section 3 presents the data sources and methodology. Section 4 discusses the empirical results. Finally, Section 5 summarizes and concludes this paper.

2. Literature Review

2.1. Candlestick Charting

In the 18th century, the Japanese developed an approach to technical analysis that traced and predicted the prices of rice contracts. This technique was referred to as candlestick charting. Candlestick charting has been developed into a more visual and descriptive study over the years. Figure 1 shows how candlestick charts are constructed. Each candlestick includes information on the high, low, opening, and closing prices in a specific time period. The difference between the opening and closing prices is called the "body", and its length depends on this difference. If the closing price is higher than the opening price, the body is white, which signals rising prices. If the opening price is higher than the closing price, the body is black, which signals falling prices. If the closing and opening prices are equal on a particular day, then the "body" of the candlestick collapses into a single horizontal line, which is referred to as a "doji". Besides, above and below the candlestick's body are "shadows", called the upper shadow and lower shadow, which represent the trading range within a specific time period.

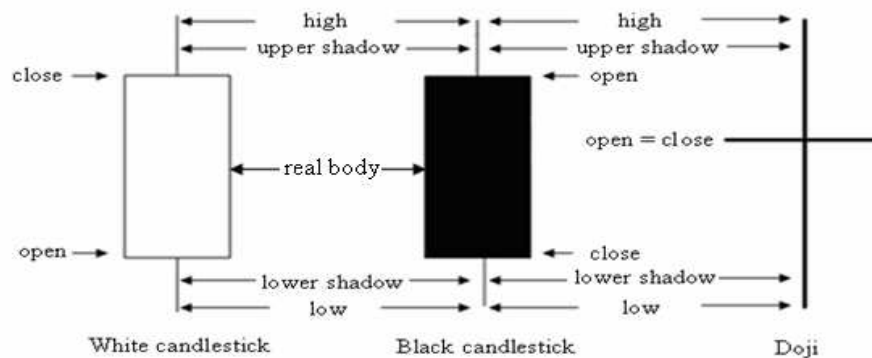

Fig. 1. Candlestick construction

If we put several single lines together, they can form continuation and reversal patterns. Continuation patterns indicate that the prevailing trend will continue, while reversal patterns suggest that there will be a change in trend. All single lines and most continuation and reversal patterns can be either of a bullish or bearish variety. In this context, the bullish patterns suggest future price increases, while the bearish patterns indicate the reverse.

There are numerous combinations of single lines that exhibit neither continuation nor reversal patterns. In addition, some continuation and reversal patterns are said to have very little, or

no, forecasting power. To determine whether a continuation or reversal pattern has strong forecasting power, proponents of candlestick technical analysis have developed a system of combining two or three individual single lines that make up the pattern to form an overall single line for the two- or three-day period. The characteristics of this overall single line are supposed to indicate whether the pattern does or does not have such forecasting power.

Furthermore, candlestick charts can be used in the analysis of different subjects. They can be used to analyze stock, foreign exchange, futures, options, and bonds, etc. and candlesticks can be combined with other technical indicators, such as KD, Moving Average (MA), and Moving Average Convergence and Divergence (MACD), etc. In this way, they provide different ways of predicting future price trends.

Finally, we shall consider the time frame in which candlesticks are used. The Japanese candlestick can be used in any time frame, from intraday time periods to long time periods. The period can extend for just one minute, five minutes, one hour, one day, one week, even one month.

2.2. Previous Studies on Candlestick Techniques

Since Steven Nison introduced the candlestick technique to the western world, this technique became a focus of attention and more and more related studies have recently emerged. Caginalp and Laurent (1998) collected daily candlestick data for all S&P 500 stocks over the 1992-1996 period and then used eight three-day reversal patterns to test them. Their study applied the Z-test to test the ability to forecast a trend change and concluded that all of these eight reversal patterns had good predictive power. In other words, the Japanese candlestick technique does have value for investors.

Fock, Klein, and Zewergel (2005) used five-minute intraday candlestick data from DAX futures on the German stock index DAX (FDAX) and Bond futures on German government bonds (FGBL) over the 2002-2003 period. They applied the t-test to test the candlesticks against a benchmark built from randomized buy signals in the underlying futures and found the candlesticks could not earn an abnormal return. After that, they added other technical indicators, such as the Moving Average (MA), the Relative Strength Index (RSI) and the Moving Average Convergence and Divergence (MACD) indicators. While there were just a few improvements in the results, they still could not find any systematic enhancement of forecasting ability. Therefore, they concluded that it is impossible to earn abnormal returns by using the candlestick technique, even if some other technical methods are used.

Marshall, Young, and Rose (2006) chose 35 stocks that comprised the Dow Jones Industrial Average (DJIA) for the period from January 1, 1992 to December 31, 2001 and used an extension of the bootstrap methodology to generate random opening, high, low, and closing prices. They used the bootstrap methodology to test the profitability of candlestick trading strategies and concluded that candlestick trading strategies did not have value for DJIA stocks.

After that study, Marshall, Young, and Cahan (2006) used the same approach to test the predictive power of candlestick trading strategies in the Japanese market. They choose the largest 100 stocks listed on the Tokyo Stock Exchange over the 1975-2004 period in the Japanese market because it is the second largest equity market in the world and it is also the place where the candlestick technique originally developed. Their results were the same as before in that candlestick trading strategies were deemed to be useless in terms of enabling investors to predict future price trends.

As in the case of technical analysis, there is still no consistent conclusion for the use of candlesticks. However, it is true that the candlestick technique has already been widely accepted by investors and that disputes regarding candlesticks will continue to rage in the academic world. This paper intends to re-examine this issue by employing emerging market data from Taiwan.

3. Data and Methodology

3.1. Data Resources

This study uses the data for a total of 25 component stocks in the Taiwan Top 50 Tracker Fund which makes up the largest 50 firms in Taiwan and the Taiwan Mid-Cap 100 Tracker Fund which makes up the largest 51-150 firms in Taiwan from 1997 to 2006, with all of the data including four pieces of stock market information: the opening, high, low, and closing prices. The closing price is ex-dividend and ex-rights, which is needed to calculate the rate of return. These stocks are care-

fully chosen from both the Taiwan Top 50 Tracker Fund and the Taiwan Mid-Cap 100 Tracker Fund. At first, we tried to use all the component stocks in the Taiwan Top 50 Tracker Fund, but we found there were not enough companies existing over the whole period from 1997 to 2006. Then, we search other companies in the Taiwan Mid-Cap 100 Tracker Fund according to their market value. Totally, we choose 25 stocks based on their market value and their codes and names are listed in Appendix A. Morris (1995) states that technical analysis is more reliable in the case of actively traded stocks, thus making the 25 component stocks that we have chosen a reasonable choice.

In total, each stock has 2,580 observations and all of this price information comes from the Taiwan Economic Journal (TEJ), which is a local data vendor. Following the candlestick definitions in Appendix B, we extract daily price information from these 25 component stocks and the frequencies for each candlestick are presented in Table 1.

Table 1

Frequency of each candlestick

Panel A: Bullish single lines	Frequency	Panel B: Bearish single lines	Frequency
Long White candle (A1)	375	Long Black candle (B1)	428
White Marubozu (A2)	518	Black Marubozu (B2)	382
Closing White Marubozu (A3)	660	Closing Black Marubozu (B3)	486
Opening White Marubozu (A4)	431	Opening Black Marubozu (B4)	341
Dragonfly Doji (A5)	79	Dragonfly Doji (B5)	155
Paper umbrella (A6)	525	Paper umbrella (B6)	1003
Panel C: Bullish reversal patterns	Frequency	Panel D: Bearish reversal patterns	Frequency
Hammer (C1)	13	Hanging (D1)	36
Bullish Engulfing (C2)	224	Bearish Engulfing (D2)	295
Piercing Line (C3)	25	Dark Cloud Cover (D3)	44
Bullish Harami (C4)	28	Bearish Harami (D4)	16
Three Inside Up (C5)	6	Three Inside Down (D5)	19
Three Outside Up (C6)	19	Three Outside Down (D6)	18
Tweezer Bottom (C7)	34	Tweezer Top (D7)	44

Note: This table shows the frequencies of each candlestick which are extracted from our data based on the candlestick definitions in Appendix B.

Not surprisingly, the frequencies for single lines are much higher than those for reversal patterns, which is because each reversal pattern is a specific sequence of single lines.

3.2. Candlestick Definition

In this study, we categorize candlesticks into four parts: bullish single lines, bearish single lines, bullish reversal patterns, and bearish reversal patterns. According to Marshall, Young, and Rose (2006), this study uses the candlesticks that they choose to test the profitability of these candlesticks. In addition, we have also consulted some leading candlestick books (Biaglow, 2002; Nison, 1991, 2003; Pring, 2002; Morris, 1992) and have tried to define these candlesticks precisely. All the candlestick definitions are shown in Appendix B.

After choosing the candlesticks, how to translate these candlestick verbal descriptions into scientific definitions is very important. This study refers to several earlier studies on Japanese candlesticks and integrates their methods to define each candlestick. First, this study uses symbols to replace candlesticks and it will help us clearly to express each candlestick. All the different symbols for candlesticks are shown in Table 2.

Secondly, the size of the real body (rb) is a critical factor in candlestick analysis because it shows the trading range between the opening (O) and closing (C) prices and represents the demand and supply forces. It is computed relative to the opening (O) and closing (C) prices as follows:

$$rb = \frac{C - O}{O} \text{ if the real body is white,} \quad (1)$$

$$rb = \frac{O - C}{C} \text{ if the real body is black.} \quad (2)$$

According to Fock et al. (2005), this study follows their approach to defining real body size. By using 20% and 80% of the deciles of the real bodies over the 1997-2006 period, we translate the candlestick's verbal definitions (small, medium, and long) into values for the 25 component stocks.

Table 2

Symbols for each candlestick

Panel A: Bullish single lines	Symbol	Panel B: Bearish single lines	Symbol
Long White candle	A1	Long Black candle	B1
White Marubozu	A2	Black Marubozu	B2
Closing White Marubozu	A3	Closing Black Marubozu	B3
Opening White Marubozu	A4	Opening Black Marubozu	B4
Dragonfly Doji	A5	Dragonfly Doji	B5
Paper umbrella	A6	Paper umbrella	B6
Panel C: Bullish reversal patterns	Symbol	Panel D: Bearish reversal patterns	Symbol
Hammer	C1	Hanging	D1
Bullish Engulfing	C2	Bearish Engulfing	D2
Piercing Line	C3	Dark Cloud Cover	D3
Bullish Harami	C4	Bearish Harami	D4
Three Inside Up	C5	Three Inside Down	D5
Three Outside Up	C6	Three Outside Down	D6
Tweezer Bottom	C7	Tweezer Top	D7

This study uses the above symbols to replace each candlestick to make it easier to refer to each candlestick.

This means that we quantify the size out of sample, right before the examination period. All results are shown in Table 3.

Table 3

Real body size of candlesticks

Size	Decile	Value of real body size
Small real body	Real body \leq 20%	Real body \leq 0,005
Medium real body	20% < Real body \leq 80%	0,005 < Real body \leq 0,029
Long real body	Real body \leq 80%	Real body \leq 0,029

Note: This table presents the value of real body size which translated from twenty and eighty deciles of the real bodies over the 1997-2006 period.

Thirdly, for bullish and bearish reversal patterns, how to define an uptrend and downtrend before these patterns is also very important because it is also a part of the definition. According to Caginalp and Laurent (1998), we label each of the three consecutive days as $t = 1$, $t = 2$, and $t = 3$, as shown in Figure 2, and then use the five-day moving average to define the trend. Therefore, the moving average on day "t" is defined by:

$$M_{avg}(t=0) = \frac{1}{5} \{C(t=-4) + C(t=-3) + C(t=-2) + C(t=-1) + C(t=0)\}, \quad (3)$$

where $C(t)$ = the closing price on day “ t ”.

The formula for the uptrend on day “ t ” is as follows:

$$M_{avg}(t=-6) < M_{avg}(t=-5) < \dots < M_{avg}(t=0). \quad (4)$$

On the contrary, the formula for the downtrend on day “ t ” is as follows:

$$M_{avg}(t=-6) > M_{avg}(t=-5) > \dots > M_{avg}(t=0). \quad (5)$$

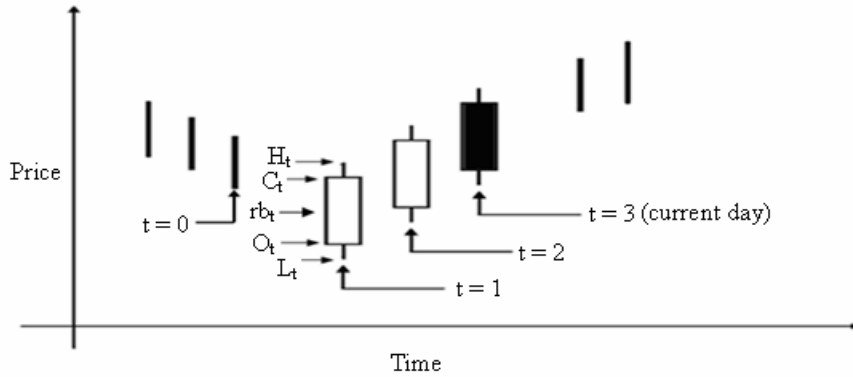

Fig. 2. Three day candlestick patterns

Figure 2 depicts how this study defines the opening (O), high (H), low (L), and closing (C) prices and real body (rb) for several consecutive days.

Finally, by following the above approaches, we can easily define each candlestick, and all of the definitions are shown in Appendix B.

3.3. Measures of Candlestick Profitability

Morris (1995, p. 213) points out that “candlestick analysis is short-term” and that any patterns that give longer-term results are surely “just coincidental”. Morris (1995) defines the maximum period that candlestick technical analysis has value as being no more than ten days. In order to test the profitability of the candlesticks and find how many holding days will be profitable, this study calculates profits based on the following assumptions:

- ◆ trades are entered at the opening price on the day following a signal;
- ◆ positions are held for one to ten days;
- ◆ trades are ended at the closing price on each holding day and the rates of return are calculated day by day;
- ◆ seven five-day moving averages are used to determine the prior trend.

At first, we calculate the mean rate of return of each candlestick on each holding day. then, the t-test is applied to test the probability of each candlestick and the hypotheses are as follows:

$$H_0: \mu_{ij} \leq 0,$$

$$H_1: \mu_{ij} > 0,$$

where μ_{it} denotes the mean rate of return of candlestick i on holding day j , $i = A1, A2, \dots, D7$ and $j = 1, 2, \dots, 10$.

After performing the t-test of the mean rate of return for each candlestick on each holding day, this study finds that some candlesticks can earn statistically significant mean rates of return on some holding days. By using these useful candlesticks and holding days, a General Linear

Model (GLM) is applied to discuss whether these two variables can significantly influence the rate of return, and the General Linear Model (GLM) in this study is as follows:

$$y_{ijk} = \mu + \alpha_i + \beta_j + (\alpha\beta)_{ij} + e_{ijk}, \tag{6}$$

where y_{ijk} = the k^{th} observation of candlestick i on holding day j , α_i = the main effect of candlestick i , β_j = the main effect of holding day j , $(\alpha\beta)_{ij}$ = the interaction effect between candlestick i and holding day j , e_{ijk} = the error term of the k^{th} observation for candlestick i on holding day j , which follows NID $(0, \sigma^2)$, i = the type of candlestick (A1, A2, ..., D6), j = holding days (1, 2, ..., 10).

At first, the overall test is used to discuss whether the main effects of the candlestick and the holding day and the interaction effect between these two variables exist (see Table 4).

Table 4

t-Tests of mean rates of return for significant candlesticks

Candlesticks	t-test	Holding days									
		1	2	3	4	5	6	7	8	9	10
Panel A: Bullish single lines											
A1	mrr	-0,16%	0,18%	0,65%	0,79%	0,93%	1,18%	1,66%	1,87%	2,09%	2,26%
	significance	-	-	y	y	y	y	y	y	y	y
A2	mrr	-0,14%	0,23%	0,10%	0,29%	0,44%	0,40%	0,42%	0,20%	0,68%	1,22%
	significance	-	-	-	-	-	-	-	-	-	y
A3	mrr	-0,13%	-0,05%	-0,02%	0,16%	0,16%	0,53%	0,68%	0,86%	1,26%	1,14%
	significance	-	-	-	-	-	y	y	y	y	y
A5	mrr	0,70%	1,33%	1,77%	2,04%	2,06%	2,13%	2,24%	2,48%	2,71%	3,06%
	significance	y	y	y	y	y	y	y	y	y	y
A6	mrr	0,07%	0,01%	0,03%	0,08%	0,24%	0,38%	0,36	0,57%	0,51%	0,63%
	significance	-	-	-	-	-	-	-	y	y	y
Panel B: Bearish single lines											
B5	mrr	0,63%	0,78%	0,75%	0,58%	0,49%	-0,38%	-0,41%	-0,83%	-0,86%	-1,12%
	significance	y	y	-	-	-	-	-	-	-	-
Panel C: Bullish reversal patterns											
C2	mrr	0,01%	0,058%	0,80%	1,20%	1,14%	0,73%	1,31%	1,86%	2,13%	1,64%
	significance	-	y	y	y	y	-	y	y	y	y
C3	mrr	1,56%	1,34%	0,25%	1,43%	2,58%	2,46%	3,51%	4,15%	4,32%	4,04%
	significance	y	-	-	-	-	-	-	y	y	y
C4	mrr	-0,36%	0,37%	1,34%	2,35%	2,33%	3,15%	3,70%	4,35%	4,62%	5,38%
	significance	-	-	-	y	y	y	y	y	y	y
C5	mrr	0,53%	2,96%	3,78%	2,48%	5,77%	6,53%	5,32%	4,14%	4,70%	3,23%
	significance			y	y	y	y	y	y	y	-
C6	mrr	1,75%	1,54%	2,23%	2,42%	0,87%	1,81%	2,80%	3,89%	4,03%	5,06%
	significance	y	-	-	-	-	-	y	y	y	y

Table 4 (continued)

Candlesticks	t-test	Holding days									
		1	2	3	4	5	6	7	8	9	10
Panel D: Bearish reversal patterns											
D2	mrr	0,32%	0,23%	0,11%	-	-	-	-	-	-	-
	significance	y	-	-	-	-	-	-	-	-	-
D3	mrr	0,96%	1,10%	2,02%	2,34%	3,01%	2,49%	2,31%	2,79%	2,58%	2,13%
	significance	y	-	y	y	y	y	y	y	y	Y
D6	mrr	0,97%	1,54%	1,65%	1,67%	-	-	-	-	-	-
	significance	-	-	y	-	-	-	-	-	-	-

This table simply shows the results of the t-tests of the mean rates of return for the significant candlesticks. "mrr" = mean rate of return, "y" = yes and "-" = no. All detailed information is provided in Appendix C.

The hypotheses are as follows:

$$H_0 : \begin{cases} \alpha_i = 0 \\ \beta_j = 0 \\ (\alpha\beta)_{ij} = 0 \end{cases} \text{ for all types of candlestick } (i) \text{ and holding days } (j),$$

H_1 : at least one equality is not satisfied.

The F-statistic is used to test the significance of the General Linear Model (GLM) and the results are shown in Table 5.

Table 5

ANOVA table of returns on candlesticks and holding days

Overall test					
Source	DF	Sum of Squares	Mean Square	F-value	p-value
Model	139	2.8097	0.0202	3.61	<.0001*
Error	9500	165.0888	0.0056		
Corrected Total	29639	167.8985			
R-Square	0.0167				
Source	DF	Sum of Squares	Mean Square	F-value	p-value
Candlesticks	13	1.6285	0.1252	22.38	<.0001*
Holding days	9	0.1750	0.0194	3.47	0.0003*
Candlesticks*Holding days	117	1.0062	0.0086	1.54	0.0002*

Notes: In this table, the function of the General Linear Model (GLM) is $y = f(A, X)$, where y = rate of return, A = candlestick, and X = holding day.

In addition, "*" denotes a significant rejection of the hypothesis in two tails at the 5% significance level.

According to Table 5, the results indicate that H_0 should be rejected, which means that the model is significant and that further research is needed. Therefore, the marginal tests of the main effects (α_i, β_j) and the interaction effect $(\alpha\beta_{ij})$ are respectively used to discuss the explanatory ability of the rate of return (y), and the null hypotheses are $H_0 : \alpha_i = 0$, $H_0 : \beta_j = 0$ and $H_0 : (\alpha\beta)_{ij} = 0$, where i = the type of candlestick, and j = holding days. The F-statistic is again used to test the significance of each marginal test and the results are presented in Table 5, which indicate that the main effects (α_i, β_j) and the interaction effect $(\alpha\beta_{ij})$ are all statistically significant. Furthermore, this study fixes the explanatory variable of the holding day and discusses the profitability of candlesticks on each holding day. The results show that if the profitability among all candlesticks is different on each holding day, then the hypotheses are as follows:

$$H_0 : \mu_{A1j} = \mu_{A2j} = \dots = \mu_{D6j},$$

$$H_1 : \text{at least one equality is not satisfied,}$$

where $\mu_{A1j}, \mu_{A2j}, \dots, \mu_{D6j}$ denote the mean rate of return for each candlestick on holding day j , and $j = 1, 2, \dots, 10$.

Meanwhile, this study also fixes the other explanatory variables for each candlestick and discusses the profitability of the holding days for each of them. The results show that if the profitability among holding days is different for each candlestick, then the hypotheses will be as follows:

$$H_0 : \mu_{i1} = \mu_{i2} = \dots = \mu_{i10},$$

$$H_1 : \text{at least one equality is not satisfied,}$$

where $\mu_{i1}, \mu_{i2}, \dots, \mu_{i10}$ denote the mean rates of return of candlestick i on each holding day, and $i = A1, A2, \dots, D6$.

The F-statistic is also used to test the above hypotheses and the p-values are shown in Tables 6 and 7.

In Table 6, if the p-value on some specific holding day is significant, this means that the profitability of different candlesticks will vary on that day. Then, Duncan's Multiple Range Test is applied to rank candlesticks on each holding day according to their profitability. Just as in Table 7, if the p-value of some specific candlestick is significant, this means that the profitability of the different holding days will vary for each candlestick. Finally, Duncan's Multiple Range Test is applied again to rank the holding days for each candlestick according to their profitability.

3.4. Stop Loss Strategy

As already mentioned, the results of the t-test show that some candlesticks on some holding days can earn statistically significant mean rates of return, and many of them belong to bullish single lines and reversal patterns. In other words, many of the bearish single lines and reversal patterns cannot earn positive mean rates of return. In order to improve these results, this study uses the concept of a stop loss strategy to control for the loss in failed trades.

The stop loss strategy is one of the most frequently used strategies to control market risk with its buy/see stops tied to the investor's open positions (Shyy, 1989). Meanwhile, trading without a stop loss is like rock-climbing without a safety harness. One small lapse in judgment could result in a catastrophe. No matter how good your analytical skills are, you will still run into trouble if you do not exit your trading positions appropriately (Louise, 2005). By using a stop loss strategy, investors should set a stop loss point that they can afford before entering the market. When a trade loss goes beyond this point, investors should end this trade. The logic of this strategy is based on the common investors' psychology, where investors are always reluctant to admit that they have failed in a trade until they lose more than they can afford. Therefore, by following this mechanized trading strategy, investors can avoid losing more than what they can afford and protect past gains.

In the long run, at least investors will reduce the probability of the losing their entire assets. Meanwhile, investors will be able to stay in the market longer and will have more chances of beating the market.

In this study, stop loss points of -5%, -7% and -10% have been tested to see if they can improve the candlestick's performance, and the results indicate that the -5% point is better than the others. Therefore, this study chooses a -5% stop loss point to control the loss from the failed trades and the way this stop loss point is calculated as follows. First, the rate of return is calculated day by day. Secondly, the low price (L) and the high price (H) on each holding day are used to decide if a trade requires a stop loss for bullish candlesticks and bearish candlesticks, respectively. Hence, for bullish single lines and reversal patterns, if the low price (L) on this day is lower than the price which causes the loss from trade to equal or exceed -5%, then the stop loss strategy will be implemented on this day and the rate of return will be -5%. On the other hand, in bearish single lines and reversal patterns, if the high price (H) on this day is higher than the price which causes the loss from trade to equal or exceed -5%, then the stop loss strategy will be implemented on this day and the rate of return will be -5%.

The way in which this study implements the stop loss strategy is as follows:

1) Bullish single lines and reversal patterns:

$$\text{if } \frac{L_{i(t+j)k} - O_{i(t+1)k}}{O_{i(t+1)k}} \leq -5\%, \text{ then the rate of return of the trade} = -5\%, \quad (7)$$

where $L_{i(t+j)k}$ = the low price of k^{th} observation of candlestick i on holding day j ,
 $O_{i(t+1)k}$ = the opening price of k^{th} observation of candlestick i on the 1st holding day,
 i = the type of candlestick (A1, A2, ..., D6), j = holding days (1, 2, ..., 10), t = current day (1, 2 or 3), k = the k^{th} observation of candlestick i .

2) Bearish single lines and reversal patterns:

$$\text{if } \frac{O_{i(t+1)k} - H_{i(t+j)k}}{O_{i(t+1)k}} \leq -5\%, \text{ then the rate of return of the trade} = -5\%, \quad (8)$$

where $H_{i(t+j)k}$ = the high price of k^{th} observation of candlestick i on holding day j ,
 $O_{i(t+1)k}$ = the opening price of k^{th} observation of candlestick i on the 1st holding day,
 i = the type of candlestick (A1, A2, ..., D6), j = holding days (1, 2, ..., 10), t = current day (1, 2 or 3), k = the k^{th} observation of candlestick i .

We sum up the rates of return based on holding days and divide by the sample frequency of the candlesticks. Then, we get the mean rate of return of each candlestick on each holding day after adopting the stop loss strategy.

Thirdly, because the trade will end if the trade loss equals or exceeds -5%, the frequency of the candlesticks will be reduced day by day. Finally, the t-statistic will be used again to test if the mean rates of return of each candlestick can be improved with a stop loss strategy, and all detailed results are shown in Appendix C.

Table 6

The p-values of the hypothesis test and Duncan's Multiple Range Test of candlesticks on each holding day

Holding days	p-value	Duncan grouping											
		A	AB	ABC	ABCD	B	BC	BCD	C	CD	D	DE	E
1	0,0002*	C6	C3	A5,B5,C5 D2,3,6			A6,C2		A1,2,3, C4				
2	0,0596	C4	A5, B5 C2,3,6 D3,6			A1,2,3,6 C4,D2							
3	0,00184*	C5	A5,C2,4,6 D3,6			A1,2,3,6,B5 C3,D2							
4	0,02*	All											
5	0,0052*	C5	A5,C3,4 D3			A1,2,3,6,B5 C2,6,D2,6							
6	0,0042*	C5	C4			A1,2,3,5,6 B5,C2,3,6							
7	<0,0001*	C5	C3,4	A1,3,5 C2,6,D3			A2,6 B5,D6		D2				
8	<0,0001*	C3,4,5,6	A1,2,3,5,6 B5, C2			D2							
9	<0,0001*	C4,5	C4,5	A1,2,3,5,6 C2,D3			B5		D2,6				
10	<0,0001*	C4,6	C4,6	C5	A1,2,3,5,6 C2,D3			B5		D6	D2		
Total	<0,0001*	C5	C5				A5,D3			A1,C2	A2,3	A6,B5, D6	D2

Note: The null hypothesis in this table is as follows: $H_0 : \mu_{A1j} = \mu_{A2j} = \dots = \mu_{D6j}$, where j = holding days. This hypothesis test seeks to determine whether the profitability among all candlesticks is totally equal on the j^{th} holding day, and then Duncan's Multiple Range Test is used to rank each candlestick on the j^{th} holding day according to their profitability. "*" denotes the significant rejection of the hypothesis in the two tails at the 5% significance level.

The p-values of ANOVA and Duncan’s Multiple Range Test of holding days for each candlestick

Candlestick	p-value	Duncan grouping													
		A	AB	ABC	ABCD	B	BC	BCD	BCDE	C	CD	CDE	D	DE	E
Long White candle (A1)	<0,0001*	10	9	8,7	6				5			3,4		2	1
White Marubozu (A2)	0,3568	10	2~9			1									
Closing White Marubozu (A3)	0,0041*	9,10	6,7,8			1~5									
Dragonfly Doji (A5)	0,8351	All													
Paper umbrella (A6)	0,4035	All													
DrBgonfly Doji (B5)	0,2462	All													
Bullish Engulfing (C2)	0,2386	8,9	2~7			1									
Piercing Line (C3)	0,7957	All													
Bullish Harami (C4)	0,0219*	9,10	7,8	3~6			2			1					
Three Inside Up (C5)	0,5385	All													
Three Outside Up (C6)	0,6669	All													
Bearish Engulfing (D2)	0,0001*	1~4	5	6				7			8,9		10		
Dark Cloud Cover (D3)	0,8779	All													
Three Outside Down (D6)	0,7658	All													
Total	0,0003*	9,10	6,7,8	4,5			2,3			1					

Note: The null hypothesis in this table is as follows: $H_0 : \mu_{i1} = \mu_{i2} = \dots = \mu_{i10}$, where i = candlestick. This hypothesis test seeks to determine whether the profitability among all holding days is totally equal for the i -th candlestick. We then use Duncan’s Multiple Range Test to rank each holding day for candlestick i according to their profitability. “*” denotes a significant rejection of the hypothesis in two tails at the 5% significance level.

4. Empirical Results

This section contains the summary statistics for the 25 component stocks in our sample. It includes the profitability statistics for each candlestick trading strategy, Duncan's Multiple Range Test of candlesticks on each holding day, Duncan's Multiple Range Test of holding days for each candlestick, and the profitability statistics for each candlestick trading strategy with a stop loss strategy.

4.1. *t*-Tests of the Mean Rate of Return

The overriding theme of the results presented here is that there is strong evidence that candlestick trading strategies based on bullish single lines, bearish single lines, bullish reversal patterns and bearish reversal patterns are profitable on these 25 component stocks in the Taiwan Top 50 Tracker Fund and Taiwan Mid-Cap 100 Tracker Fund from 1997 to 2006.

According to Table 1, the results indicate that the mean rates of return of A1, A2, A3, A5 and A6 in bullish single lines, B5 in bearish single lines, C2 to C6 in bullish reversal patterns and D2, D3 and D6 in bearish reversal patterns are statistically significant on some specific holding days. These results have proved that these candlesticks earn a positive mean rate of return on some specific holding days and can be used by investors.

The spare candlesticks cannot earn a significant positive mean rate of return, which means that these candlesticks cannot be used by investors. However, according to Table 1, if we divide the candlesticks into those characterized by single lines and those characterized by reversal patterns, it is obvious that bullish single lines perform better than bearish single lines, and bullish reversal patterns also perform better than bearish reversal patterns. Moreover, if we compare single lines with reversal patterns, the results show that bullish reversal patterns are much more profitable than bullish single lines, but that bearish reversal patterns are only a little more profitable than bearish single lines. These results are reasonable because the candlestick reversal patterns are combined with several single lines, which means that the candlestick reversal pattern is further confirmation of the single lines. Hence, the candlestick reversal pattern should be more profitable than the candlestick single line. Finally, by using the above results, investors can find which candlestick can be used for trading and for how many holding days investors should long or short a stock.

4.2. General Linear Model (GLM)

In this study, we use the General Linear Model (GLM) to discuss the relationships among the rates of return, candlesticks and holding days. According to the ANOVA table (Table 5), first, the p-value of the overall test indicates that the General Linear Model (GLM) is significant and that further research is needed. Secondly, the marginal test of the General Linear Model (GLM) seeks to determine whether the main effects of the candlesticks (α_i) and holding days (β_j) and the interaction effect between these two variables ($\alpha\beta_{ij}$) significantly influence the rate of return (y). The results show that all of these effects are significant, which means that the candlesticks and holding days are valid explanatory variables for the rate of return (y) and that the interaction effect between these two explanatory variables is also seen to exist. Thirdly, we fix the explanatory variable for the holding days and try to test whether the profitability among all candlesticks is totally equal (H_0) on each holding day. According to Table 6, the results show that the p-values are all significant except the 2nd holding day, which means that the profitability among all candlesticks exhibits a difference on each holding day except the 2nd day. Then, Duncan's Multiple Range Test is used to compare the profitability of each candlestick on each holding day. Finally, we fix the other explanatory variable for the candlesticks and try to determine whether the profitability among all holding days is totally equal for each candlestick. According to Table 7, the results show that the profitability of each holding day exhibits a difference only in the case of the candlesticks for A1, A3, C4 and D2. This means that some holding days are more profitable than others for these four candlesticks. Besides, the p-value for all candlesticks is also significant, which means that some holding days can really result in more profit than others for all of these candle-

sticks. Then, Duncan's Multiple Range Test is again used to rank each holding day according to their profitability.

4.3. Duncan's Multiple Range Test of Candlesticks on Each Holding Day

According to Table 6, in Duncan's Multiple Range Test of candlesticks on each holding day, all p-values of the hypothesis tests are significant except for the 2nd holding day. This means that the explanatory variable (the candlesticks) influences the response variable (rate of return) significantly on all holding days, except the 2nd day. Therefore, we do not need to consider the result of Duncan's Multiple Range Test on the 2nd holding day. Besides, although the p-value of the hypothesis test on the 4th holding day is significant, the result of Duncan's Multiple Range Test shows that all candlesticks belong to the A group, which means that the profitability among all of the candlesticks is no different on this day. Then, we also do not consider the result on the 4th holding day.

The overall results of Duncan's Multiple Range Test show that the bullish reversal patterns perform better than other parts of the candlesticks. In particular, C5 belongs to the A group on the 3rd and the 5th to 9th holding days, and the mean rates of return on these days are also significant in the t-test. Besides, C4 belongs to A group from the 8th to the 10th holding days, and C6 belongs to the A group on the 1st, the 8th, and the 10th holding days. Their mean rates of return on these days are also statistically significant according to the t-test. Moreover, C3 belongs to the A group only on the 8th holding day and the mean rate of return is also significant according to the t-test. The above results imply that these candlesticks can not only be used for investors but also perform better than the others on these holding days. If we consider the profitability of candlesticks on all holding days (total), C5 is the best signal (in the A group), and C3, C4 and C6 also perform well (in the AB group). There are no other candlesticks in terms of bullish single lines, bearish single lines and bearish reversal patterns belonging to the A group based on Duncan's Multiple Range Test. This is further evidence that the bullish reversal patterns perform the best. Besides, the results also show that A5 (in the BC group) performs better than the others except for A1 (in the CD group) in terms of the bullish single lines. Furthermore, in regard to the bearish single lines, as mentioned, B5 is the only candlestick which can be used, but it cannot perform better than any other candlesticks. Finally, as for the bearish reversal patterns, D3 (in the BC group) performs better than D2 (in the E group) and D6 (in the DE group).

4.4. Duncan's Multiple Range Test of Holding Days for Each Candlestick

According to Table 7, in Duncan's Multiple Range Test of the holding days for each candlestick, the p-values of the hypothesis test are significant in the cases of A1, A3, C4 and D2, which means that the probabilities among all holding days are not totally equal for these candlesticks. For A1, A3 and C4, it is obvious that a long holding period will be suitable for these candlesticks because the 9th and the 10th holding days belong to the A or AB groups of these candlesticks. Besides, their mean rates of return on these days are significant and also the highest recorded according to the t-test. The results imply that investors should buy and hold the stock for nine or ten days by following these signals. On the contrary, D2 needs a short holding period because the 1st to the 4th holding days belong to the A group, and its mean rate of return is only significant on the 1st holding day in the t-test. Therefore, this is further confirmation that to hold the stock just one day will be suitable for this signal. Finally, the p-values of the other candlesticks are not significant, which means that differences in terms of the profitability among the holding days on these candlesticks do not exist.

4.5. t-Tests of Mean Rates of Return with Stop Loss Strategy

As already mentioned, this study uses a -5% stop loss point to improve the performance of candlesticks. We calculate the rate of return day by day and if the rate of return on a certain holding day falls by more than -5%, the trade will be ended and the rate of return on the later holding days will not be calculated. Therefore, the sample frequency will decline day by day and the results will show how much of a mean rate of return the investor can earn by following the -5% stop loss strategy. If the mean rate of return is significant on the 1st holding day, the investor can

Table 8 (continued)

Candlesticks	t-test	Holding days									
		1	2	3	4	5	6	7	8	9	10
Panel C: Bullish reversal patterns											
C1	mrr	0.71%	-0.52%	1.02%	1.49%	1.91%	2.06%	3.21%	4.52%	6.20%	6.66%
	signifi- cance	-	-	-	-	-	-	-	-	y	y
C2	mrr	0.03%	0.77%	2.40%	3.68%	4.03%	5.17%	6.17%	7.31%	8.00%	8.04%
	signifi- cance	-	y	y	y	y	y	y	y	y	y
C3	mrr	1.63%	1.68%	1.76%	4.98%	6.52%	7.45%	9.23%	9.97%	10.91%	9.81%
	signifi- cance	y	y	-	y	y	y	y	y	y	y
C4	mrr	-0.36%	0.11%	2.65%	4.26%	3.56%	5.46%	7.08%	8.14%	8.84%	9.99%
	signifi- cance	-	-	y	y	y	y	y	y	y	y
C5	mrr	0.53%	2.87%	4.71%	2.26%	5.68%	6.95%	5.68%	4.44%	3.86%	1.38%
	signifi- cance	-	-	y	-	y	y	y	y	y	y
C6	mrr	1.75%	2.26%	3.81%	4.94%	4.36%	4.82%	4.63%	5.61%	5.86%	6.68%
	signifi- cance	y	y	y	y	y	y	y	y	y	y
C7	mrr	-0.79%	0.65%	1.98%	2.10%	2.28%	2.69%	3.10%	2.75%	2.81%	3.48%
	signifi- cance	-	-	y	y	y	y	y	y	y	Y
Panel D: Bearish reversal patterns											
D1	mrr	-0.32%	-0.29%	0.67%	0.17%	-0.29%	-0.08%	-0.30%	0.53%	0.91%	1.17%
	signifi- cance	-	-	-	-	-	-	-	-	-	-
D2	mrr	0.34%	0.38%	1.36%	2.10%	2.38%	2.52%	3.12%	3.65%	4.05%	4.30%
	signifi- cance	y	y	y	y	y	y	y	y	y	y
D3	mrr	0.93%	1.54%	3.31%	3.48%	3.86%	3.49%	3.36%	4.08%	6.21%	5.90%
	signifi- cance	y	y	y	y	y	y	y	y	y	y
D4	mrr	1.14%	1.97%	0.87%	1.78%	3.72%	3.37%	4.12%	3.72%	6.84%	7.11%
	signifi- cance	-	y	-	-	y	y	y	y	y	y
D5	mrr	-0.28%	-0.21%	2.14%	2.19%	3.64%	2.44%	4.42%	4.73%	5.31%	5.96%
	signifi- cance	-	-	-	-	y	-	y	y	y	y
D6	mrr	0.97%	1.54%	1.43%	1.85%	1.41%	3.90%	4.07%	3.40%	3.30%	2.86%
	signifi- cance	-	-	-	-	-	y	y	y	y	y
D7	mrr	-28%	0.75%	1.27%	0.90%	1.31%	2.51%	2.77%	3.04%	3.03%	3.43%
	signifi- cance	-	-	-	-	-	y	y	y	y	y

Note: This table simply presents the mean rate of return for each candlestick on each holding day and states whether it is significant after the -5% stop loss point. "mrr" = mean rate of return, "y" = yes, and "-" = no. All detailed information is provided in Appendix C.

The results show after how many holding days the mean rate of return starts to be significantly positive and how much the mean rate of return on each holding day will be after the -5% stop loss strategy is implemented. For example, in the case of B1, the mean rate of return is never significant in the t-test without a stop loss strategy. However, by following the -5% stop loss strategy, a significantly positive mean rate of return can be earned from the 3rd to the 10th holding days. Investors can expect to earn mean rates of return between 1.3% and 5.94% if they never lose more than -5% before each holding day.

For those candlesticks for which the mean rates of return are not significant in the t-test without the stop loss strategy, all of those characterized by bullish and bearish single lines start to earn significantly positive mean rates of return from the 3rd holding day onwards. In particular, the mean rates of return of B6 start to be significant on the 1st holding day. In this case, by following the -5% stop loss strategy, investors can surely earn a 0.11% mean rate of return if they short the stock for just one day. Otherwise, for the bullish reversal patterns, the mean rates of return of C1 and C7 start to be significant from the 9th and the 3rd holding days, respectively. Finally, for the bearish reversal patterns, the mean rates of return of D4, D5 and D7 start to be significant from the 2nd, the 5th and the 6th holding days, respectively, and D1 is the only candlestick which still cannot be used for investors by following the -5% stop loss strategy.

5. Summary and Conclusions

The results of this study indicate that the use of the oldest known form of technical analysis, Japanese candlestick trading strategies, does have value for 25 component stocks of the Taiwan Top 50 Tracker Fund and the Taiwan Mid-Cap 100 Tracker Fund over the period from 1997 to 2006. This study finds that many candlestick single lines and reversal patterns can really help investors earn significantly positive mean rates of return by following candlestick trading strategies. Besides, many of the candlesticks which can be used for investors are characterized by bullish single lines and reversal patterns. Furthermore, bullish candlesticks are much more profitable than bearish candlesticks and candlestick reversal patterns also perform much better than candlestick single lines. This finding is reasonable because candlestick reversal patterns are further confirmation of candlestick single lines. The findings in this study also indicate that bullish reversal patterns are the best type of the candlesticks which bring the highest mean rates of return to investors.

This study also finds the profitability trends of the candlesticks, which means different candlesticks really need to have different holding days. For bullish single lines and reversal patterns, a long holding period is suitable for these candlesticks because the trend in the mean rates of return goes up. The mean rates of return for bullish candlesticks always perform the best on the 9th or the 10th holding days, except for C5. For C5, the mean rate of return performs the best on the 6th holding day. On the contrary, for bearish single lines and reversal patterns, a short holding period will be suitable for these candlesticks because the trend in the mean rates of return goes down. The mean rates of return for bearish candlesticks perform the best on the 1st, 2nd, or 3rd holding days, except in the case of D3. For D3, it will be profitable to short the stock for three to ten days, which should result in earnings of 2% above the mean rate of return and lead to the highest return on the 5th holding day.

Finally, in this study, we use the -5% stop loss point to control the loss of failed trades and to try to improve the performance of candlesticks. As a result of following the -5% stop loss point, most candlesticks' mean rates of return are seen to have improved, except for D1. Although this study still cannot guarantee that investors will earn the mean rate of return on each holding day by following this strategy since we are not sure how many times investors will apply such a stop loss before each holding day, this study provides a new way for the investor to know how much the mean rate will be by following this strategy. Investors will then be able to start considering whether the mean rate of return is sufficiently attractive to them to take the required risk and enter the market. For example, if D4 emerges, our results have proved that investors cannot use this signal to earn a significantly positive mean rate of return. However, if they follow the -5% stop loss strategy, these investors can earn a 7.11% mean rate of return if the trade does not lose more than -5% before the 10th holding day. Then, investors can make a decision if they want to take the risk and earn a 7.11% mean rate of return by buying and holding the stock for ten days.

In an earlier candlestick study by Marshall, Young and Rose (2006), the authors chose candlesticks that had explanatory power and also occurred frequently. Besides, they chose stocks which were part of the DJIA index, which means that the market value of these stocks was absolutely huge in America. By following their approach, our study uses the candlesticks that they chose as well as those stocks that are component stocks of the Taiwan Top 50 Tracker Fund and the Taiwan Mid-Cap 100 Tracker Fund. According to Marshall, Young, and Rose (2006), their findings show that bullish single lines and reversal patterns generally signal positive future returns, but that profits are positive less than 50% of the time. On the contrary, bearish single lines and reversal patterns generally signal negative future returns, but profits are positive over 50% of the time. Therefore, they conclude that candlestick trading strategies do not have value for investors. In our study, we have similar findings to those of Marshall, Young, and Rose (2006). We also find that bullish single lines and reversal patterns generally earn positive profits and that bearish single lines and reversal patterns earn negative profits. However, the profit from bullish single lines and reversal patterns in our study exhibits much better performance than that of Marshall, Young, and Rose (2006). In the study by Marshall, Young and Rose (2006), although bullish single lines and reversal patterns generally signal positive future returns, all of these candlesticks earn no more than 0.1% in terms of average daily profit. In our study, for those candlesticks that perform significantly in terms of the t-tests, most of them can earn more than a 1% mean rate of return, and even more than 6%. Besides, we also find some bearish single lines and reversal patterns which can be used for investors. Hence, these results indicate that candlestick trading strategies can be used in the Taiwan stock market.

In summary, there is no doubt that this study does have substantial value for investors in terms of enabling them to use candlestick techniques properly, and then in terms of improving their investment performance. Contrary to the findings of Marshall, Young, and Rose (2006) who find that the U.S. market is informationally efficient because candlestick trading strategies do not have value for Dow Jones Industrial Average (DJIA) stocks, this study, however, finds some counterevidence to efficient market argument in the Taiwan stock markets.

References

1. Alexander, S., 1964, "Price Movements in Speculative Markets: Trends or Random Walks", *Industrial Management Review*, 2, 7-26.
2. Berenson, M.L. and D.M. Levine, 1999, *Basic Business Statistics*, seventh ed., Prentice-Hall International Inc., New Jersey.
3. Bigalow, S., 2002, *Profitable Candlestick Trading*, John Wiley and Sons, New York.
4. Brock, W., J. Lakonishok and B. LeBaron, 1992, "Simple Technical Trading Rules and the Stochastic Properties of Stock Returns", *Journal of Finance*, 47, 1731-1764.
5. Caginalp, G. and H. Laurent, 1998, "The Predictive Power of Price Patterns", *Applied Mathematical Finance*, 5, 181-205.
6. Duncan, D.B., 1957, "Multiple Range Tests for Correlated and Heteroscedastic Means", *Biometrics*, 13, 164-176.
7. Fama, E.F., 1965, "The Behavior of Stock-Market Prices", *Journal of Business*, 38, 34-105.
8. Fama, E.F. and M.E. Blume, 1966, "Filter Rules and Stock-Market Trading", *Journal of Business*, 39, 226-241.
9. Fama, E.F. and K.R. French, 1986, "Permanent and Temporary Components of Stock Prices", *Journal of Political Economy*, 98, 246-274.
10. Fock, J.H., C. Klein and B. Zwergel, 2005, "Performance of Candlestick Analysis on Intraday Futures Data", *Journal of Futures Markets*, 13, 28-40.
11. James, F. E., 1968, "Monthly Moving Averages – an Effective Investment Tool?" *Journal of Finance and Quantitative Analysis*, 3, 315-326.
12. Louise, B., 2005, "Braking Even with a Stop," *Money*, 6, 28.
13. Malkiel, B., 1981, *A Random Walk Down Wall Street*, second ed., Norton, New York.
14. Marshall, B.R., M.R. Young and L.C. Rose, 2006, "Candlestick Technical Trading Strategies: Can They Create Value for Investors?" *Journal of Banking & Finance*, 30, 2303-2323.











15. Marshall, B. R., M. R. Young and R. Cahan, 2006, "Are Candlestick Technical Trading Strategies Profitable in the Japanese Equity Market?" Working Paper, Massey University.
16. Mills, T.C., 1997, "Technical Analysis and the London Stock Exchange: Testing Trading Rules Using the FT30", *International Journal of Finance & Economics*, 2, 319-331.
17. Morris, G.L., 1992, *Candlepower, Advanced Candlestick Pattern Recognition and Filtering Techniques for Trading Stocks and Futures*, Probus Inc., Chicago.
18. Morris, G.L., 1995, *Candlestick Charting Explained: Time Techniques for Trading Stocks and Futures*, Second ed., McGraw-Hill Trade, New York.
19. Myers, R.H., D.C. Montgomery and G.G. Vining, 2002, *Generalized Linear Models*, John Wiley and Sons, New York.
20. Nison, S., *Japanese Candlestick Charting Techniques*, New York Institute of Finance, 1991.
21. Nison, S., 2003, *The Candlestick Course*, John Wiley and Sons, New York.
22. Pring, M., 2002, *Candlesticks Explained*, McGraw-Hill, New York.
23. Shyy, G., 1989, "Gambler's Ruin and Optimal Stop Loss Strategy", *Journal of Futures Markets*, 9, 565-571.
24. Sweeney, R.J., 1988, "Some New Filter Rule Tests: Methods and Results", *Journal of Finance and Quantitative Analysis*, 23, 285-300.
25. Van Horne, J.C. and G.C. Parker, 1967, "The Random Walk Theory: An Empirical Test", *Financial Analysts Journal*, 87-92.

Appendix A: The 25 component stocks

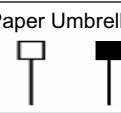
Code	Name
2353	Acer Incorporated
2311	Advanced Semiconductor Engineering, Incorporated
2357	Asustek Computer Incorporated
2801	Chang Hwa Commercial Bank, Limited
2002	China Steel Corporation
2324	Compal Electronics, Incorporated
2308	Delta Electronics, Incorporated
2603	Evergreen Marine Corporation, Limited
1402	Far Eastern Textile Limited
1326	Formosa Chemicals & Fibre Corporation
1301	Formosa Plastics Corporation
2354	Foxconn Technology Corporation, Incorporated
2317	Hon Hai Precision Ind. Corporation, Incorporated
2301	Lite-on Technology Corporation
1303	Nan Ya Plastics Corporation
9904	Pou Chen Corporation
2325	Siliconware Precision Industries Corporation, Incorporated
2330	Taiwan Semiconductor Manufacturing Corporation, Incorporated
1216	Uni-President Enterprises Corporation
2303	United Microelectronics Corporation
6004	Yuanta Core Pacific Securities
2356	Inventec Corporation
2371	Tatung Corporation
1605	Walsin Lihwa Corporation
1101	Taiwan Cement Corporation







Note: This appendix shows the codes and the names of the 25 component stocks which are carefully chosen from the Taiwan Top 50 Tracker Fund and the Taiwan Mid-Cap 100 Tracker Fund in this study.

Appendix B: Candlestick definitions

Candlesticks	1st		2nd		3rd		Price condition	Trend
	Co ₁	rb ₁	Co ₂	rb ₂	Co ₃	rb ₃		
Panel A: Bullish single lines								
Long White Candle (A1) 	w	lo	nd	nd	nd	nd	$H_1 > C_1 > O_1 > L_1$	nd
White Marubozu (A2) 	w	lo	nd	nd	nd	nd	$H_1 = C_1 > O_1 = L_1$	nd
Closing White Marubozu (A3) 	w	lo	nd	nd	nd	nd	$H_1 = C_1 > O_1 > L_1$	nd
Opening White Marubozu (A4) 	w	lo	nd	nd	nd	nd	$H_1 > C_1 > O_1 = L_1$	nd
Dragonfly Doji (A5) 	nd	d	nd	nd	nd	nd	$H_1 = C_1 = O_1 > L_1$ & $ls_1 > 0.029$	nd
Paper Umbrella (A6) 	nd	s	nd	nd	nd	nd	$H_1 = C_1 > O_1 > L_1$ & $ls_1 > 2 * rb_1$ or $H_1 = O_1 > C_1 > L_1$ & $ls_1 > 2 * rb_1$	nd
Panel B: Bearish single lines								
Long Black Candle (B1) 	b	lo	nd	nd	nd	nd	$H_1 > O_1 > C_1 > L_1$	nd
Black Marubozu (B2) 	b	lo	nd	nd	nd	nd	$H_1 = O_1 > C_1 = L_1$	nd
Closing Black Marubozu (B3) 	b	lo	nd	nd	nd	nd	$H_1 > O_1 > C_1 = L_1$	nd
Opening Black Marubozu (B4) 	b	lo	nd	nd	nd	nd	$H_1 = O_1 > C_1 > L_1$	nd
Gravestone Doji (B5) 	nd	d	nd	nd	nd	nd	$H_1 > O_1 = C_1 = L_1$ & $us_1 > 0.029$	nd
Shooting Star (B6) 	nd	s	nd	nd	nd	nd	$H_1 > C_1 > O_1 = L_1$ & $us_1 > 2 * rb_1$ or $H_1 > O_1 > C_1 = L_1$ & $us_1 > 2 * rb_1$	nd



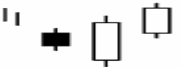

Note: Color (co): white (w); black (b); no definition (nd). Real body (rb): doji (d); small (s); medium (m); long (lo). Price: high (h); closing (c); opening (o); low (l); upper shadow (us); lower shadow (ls); middle of real body (mrb). Trend: uptrend (ut); downtrend (dt).

Appendix B: Candlestick definitions (continued)

Candlesticks	1st		2nd		3rd		Price condition	Trend
	Co ₁	rb ₁	Co ₂	rb ₂	Co ₃	rb ₃		
Panel C: Bullish reversal patterns								
Hammer (C1) 	w	s	nd	nd	nd	nd	$H_1 = C_1 > O_1 > L_1 \text{ \& } l_{s1} > 2 * rb_1$	dt
Bullish Engulfing (C2) 	b	nd	w	lo	nd	nd	$C_2 > O_1 > C_1 > O_2$	dt
Piercing Line (C3) 	b	lo	w	nd	nd	nd	$O_1 > C_2 > L_1 > O_2 \text{ \& } C_2 > 0.5 * (O_1 + C_1)$	dt
Bullish Harami (C4) 	nd	lo	w	nd	nd	nd	$O_1 \square C_2 > O_2 \square C_1 \text{ \& } rb_1 > rb_2$ or $C_1 \square C_2 > O_2 \square O_1 \text{ \& } rb_1 > rb_2$	dt
Three Inside Up (C5) 	nd	lo	w	nd	w	nd	$\{O_1 \square H_1 \square C_2 > O_2 \square L_2 \square C_1 \text{ or } C_1 \square H_1 \square C_2 > O_2 \square L_2 \square O_1\}$ & $rb_1 > rb_2 \text{ \& } C_3 > O_3 \text{ \& } C_3 > C_2$	dt
Three Outside Up (C6) 	b	nd	w	lo	w	nd	$C_2 > O_1 > C_1 > O_2$ & $C_3 > O_3 \text{ \& } C_3 > C_2$	dt
Tweezer Bottom (C7) 	nd	nd	nd	nd	nd	nd	$L_1 = L_2$	dt

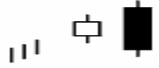
Note: Color (co): white (w); black (b); no definition (nd). Real body (rb): doji (d); small (s); medium (m); long (lo). Price: high (h); closing (c); opening (o); low (l); upper shadow (us); lower shadow (ls); middle of real body (mrb). Trend: uptrend (ut); downtrend (dt).

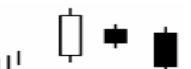
Appendix B: Candlestick definitions (continued)

Candlesticks	1st		2nd		3rd		Price condition	Trend
	Co ₁	rb ₁	Co ₂	rb ₂	Co ₃	rb ₃		
Panel D: Bearish reversal patterns								
Hanging Man (D1) 	b	s	nd	nd	nd	nd	$H_1 = O_1 > C_1 > L_1$ & $ls_1 > 2 * rb_1$	ut
Bearish Engulfing (D2) 	w	nd	b	lo	nd	nd	$O_2 > C_1 > O_1 > C_2$	ut
Dark Cloud Cover (D3) 	w	lo	b	lo	nd	nd	$O_2 > H_1 > C_2 > O_1$ & $C_2 < 0.5 * (C_1 + O_1)$	ut
Bearish Harami (D4) 	nd	lo	b	nd	nd	nd	$C_1 \square O_2 > C_2 \square O_1$ & $rb_1 > rb_2$ or $O_1 \square O_2 > C_2 \square C_1$ & $rb_1 > rb_2$	ut
Three Inside Down (D5) 	nd	lo	b	nd	b	nd	$\{C_1 \square H_2 \square O_2 > C_2 \square L_2 \square O_1$ or $O_1 \square H_2 \square O_2 > C_2 \square L_2 \square C_1\}$ & $rb_1 > rb_2$ & $C_3 < O_3$ & $C_3 < C_2$	ut
Three Outside Down (D6) 	w	nd	b	lo	b	nd	$O_2 > C_1 > O_1 > C_2$ & $C_3 < O_3$ & $C_3 < C_2$	ut
Tweezer Top (D7) 	nd	nd	nd	nd	nd	nd	$H_1 = H_2$	ut

Note: Color (co): white (w); black (b); no definition (nd). Real body (rb): doji (d); small (s); medium (m); long (lo). Price: high (h); closing (c); opening (o); low (l); upper shadow (us); lower shadow (ls); middle of real body (mrb). Trend: uptrend (ut); downtrend (dt).

Appendix C: t-Tests of mean rates of return for each candlestick on each holding day

Candlesticks		Holding days									
		1	2	3	4	5	6	7	8	9	10
Panel A: Bullish single lines											
Long White Candle (A1)	Frequency	375									
	Mean rate of return	-0.16%	0.18%	0.65%	0.79%	0.93%	1.18%	1.66%	1.87%	2.09%	2.26%
	t-value	-0.98	0.73	2.19*	2.37*	2.52*	2.90*	3.53*	3.75*	44.10*	44.39*
	Frequency (sl)	375	343	295	267	251	229	218	207	1194	187
	Mean of return (sl)	-0.14%	0.66%	2.04%	2.83%	3.42%	44.41%	55.58%	66.36%	77.17%	77.35%
	t-value (sl)	-0.91	2.93*	66.71*	88.14	88.55*	99.31*	10.04*	10.57*	11.36*	11.51*
White Marubozu (A2)	Frequency	518									
	Mean rate of return	-0.14%	0.23%	0.10%	0.29%	0.44%	0.40%	0.42%	0.20%	0.68%	1.2%
	t-value	-1.03	1.14	0.42	1.0	1.31	1.10	1.08	0.47	1.56	2.57*
	Frequency (sl)	5518	4472	398	361	327	301	280	261	245	242
	Mean of return (sl)	-0.14%	0.68%	1.67%	2.51%	3.62%	44.14%	44.80%	55.36%	66.54%	77.27%
	t-value (sl)	-1.05	3.37*	77.02*	88.53*	10.34*	10.95*	11.79*	11.59*	13.62*	12.85*
Closing White Marubozu (A3)	Frequency	660									
	Mean rate of return	-0.13%	-0.05%	-0.02%	0.16%	0.16%	0.53%	0.68%	0.86%	1.26%	1.14%
	t-value	-1.09	-0.28	-0.08	0.63	0.55	1.67*	1.92*	2.26*	3.13*	2.76*
	Frequency (sl)	6660	5585	4493	4421	373	340	318	296	281	268
	Mean of return (sl)	-0.17%	0.58%	1.60%	2.82%	3.70%	44.95%	55.87%	66.74%	77.60%	77.75%
	t-value (sl)	-1.45	3.21*	66.75*	99.76*	10.95*	12.83*	12.89*	13.62*	13.76*	13.27*

Note: "sl" = stop loss; "*" denotes significant rejection of hypothesis in one tail at the 5% significance level.

Appendix C: t-Tests of mean rates of return for each candlestick on each holding day (continued)

Candlesticks		Holding days									
		1	2	3	4	5	6	7	8	9	10
Panel A: Bearish single lines											
Opening White Marubozu (A4)	Frequency	431									
	Mean rate of return	-0,46%	-0,37%	-0,46%	-0,20%	-0,01%	-0,12%	-0,23%	-0,2%	-0,23%	0,19%
	t-value	-3,43	-1,82	-1,96	-0,73	-0,03	-0,32	-0,61	-0,53	-0,52	0,39
	Frequency (sl)	4431	396	337	291	268	258	249	226	21	203
	Mean of return (sl)	-0,44%	0,10%	0,76%	1,89%	2,72%	3,1%	3,62%	44,49%	55,19%	66,21%
	t-value (sl)	3-3,38	0,51	3,2*	66,47*	88,21*	77,96*	88,73*	99,12*	99,43*	99,65*
Dragonfly Doji (A5)	Frequency	79									
	Mean rate of return	0,70%	51,3%	%1,77%	%2,04%	%2,06%	%2,13%	%2,24%	%2,48%	%2,71%	%3,06%
	t-value	2,18*	2,29*	2,57*	2,67*	2,54*	2,58*	2,35*	2,17*	2,15*	2,41*
	Frequency (sl)	779	776	666	559	555	553	551	449	449	445
	Mean of return (sl)	0,70%	1,70%	3,07%	4,02%	4,54%	4,56%	5,15%	6,28%	6,49%	57,58%
	t-value (sl)	2,20*	3,20*	44,56*	55,26*	55,62*	55,32*	55,27*	44,93*	4,37*	55,13*
Paper Umbrella (A6)	Frequency	525									
	Mean rate of return	0,07%	0,01%	0,03%	50,08%	50,24%	0,38%	0,36%	0,57%	0,51%	0,63%
	t-value	0,84	0,09	0,16	0,40	1,14	1,59	1,36	1,98*	1,70*	1,96*
	Frequency (sl)	5525	5514	4482	4447	4427	4405	388	377	366	353
	Mean of return (sl)	0,04%	0,06%	0,42%	0,93%	1,38%	1,92%	2,31%	2,60%	2,80%	3,20%
	t-value (sl)	0,41	0,51	2,74*	55,21*	66,99*	88,68*	99,40*	99,25*	99,20*	99,85*

Note: "sl" = stop loss; "*" denotes significant rejection of hypothesis in one tail at the 5% significance level.

Appendix C: t-Tests of mean rates of return for each candlestick on each holding day (continued)

Candlesticks		Holding days									
		1	2	3	4	5	6	7	8	9	10
Panel B: Bearish single lines											
Long Black Candle (B1)	Frequency	428									
	Mean rate of return	-0,33%	-0,20%	-0,31%	-0,89%	-1,45%	-1,85%	-2,06%	-2,06%	-1,82%	-1,95%
	t-value	-2,18	-0,93	-1,14	-2,62	-3,84	-4,29	-4,35	-4,01	-3,37	-3,50
	Frequency (sl)	428	381	316	280	256	230	206	193	180	170
	Mean of return (sl)	-0,30%	0,29%	1,30%	1,96%	2,04%	2,82%	3,83%	4,60%	5,40%	5,94%
	t-value (sl)	-2,03	1,34	5,13*	6,55*	6,28*	8,06*	9,41*	10,14*	10,68*	11,04*
Black (Marubozu) (B2)	Frequency	382									
	Mean rate of return	-0,08%	-0,27%	-0,23%	-0,84%	-1,28%	-1,66%	-2,18%	-2,80%	-3,05%	-3,52%
	t-value	-0,47	-1,11	-0,75	-2,32	-3,19	-3,78	-4,65	-5,70	-5,73	-6,25
	Frequency (sl)	382	344	290	240	217	196	175	156	148	136
	Mean of return (sl)	-0,05%	0,31%	1,19%	2,44%	2,81%	3,14%	3,86%	4,33%	4,94%	5,49%
	t-value (sl)	-0,35	1,39	4,03*	7,22*	7,11*	7,26*	7,95*	8,78*	9,10*	9,90*
Closing Black Marubozu (B3)	Frequency	486									
	Mean rate of return	-0,56%	-0,96%	-1,44%	-2,14%	-2,63%	-2,74%	-2,84%	-2,75%	-2,46%	-2,57%
	t-value	-3,85	-4,13	-4,94	-6,02	-6,61	-6,47	-6,35	-5,74	-4,78	-4,73
	Frequency (sl)	486	421	330	279	245	230	203	190	179	176
	Mean of return (sl)	-0,54%	0,03%	1,12%	2,06%	2,64%	2,91%	3,66%	4,24%	5,21%	5,68%
	t-value (sl)	-3,84	0,14	4,47*	7,03*	8,06*	7,96*	9,32*	9,45*	10,73*	10,75*

Note: "sl" = stop loss; "*" denotes significant rejection of hypothesis in one tail at the 5% significance level.

Appendix C: t-Tests of mean rates of return for each candlestick on each holding day (continued)

Candlesticks		Holding days									
		1	2	3	4	5	6	7	8	9	10
Panel A: Bearish single lines											
Opening Black Marubozu (B4)	Frequency	341									
	Mean rate of return	-0,16%	-0,03%	0,07%	-0,15%	-0,54%	-0,50%	-0,94%	-0,72%	-0,56%	-0,56%
	t-value	-1,04	-0,11	0,26	-0,49	-1,47	-1,17	-2,13	-1,60	-1,13	-1,06
	Frequency (sl)	341	317	273	245	223	202	185	179	165	162
	Mean of return (sl)	-0,14%	0,32%	1,26%	1,73%	2,12%	3,12%	3,50%	3,88%	5,00%	5,51%
	t-value (sl)	-0,91	1,46	4,73*	5,70*	5,95*	7,52*	8,18*	8,27*	9,40*	9,74*
Gravestone (B5)	Frequency	155									
	Mean rate of return	0,63%	0,78%	0,75%	0,58%	0,49%	-0,38%	-0,41%	-0,83%	-0,86%	-1,12%
	t-value	2,11*	2,03*	1,54	1,01	0,80	-0,53	-0,53	-0,97	-1,01	-1,33
	Frequency (sl)	155	140	125	103	92	85	80	76	72	66
	Mean of return (sl)	0,73%	1,37%	1,96%	3,26%	3,80%	4,08%	4,51%	4,58%	5,15%	5,60%
	t-value (sl)	2,74*	3,77*	4,22*	5,95*	6,69*	6,41*	7,02*	6,65*	7,10*	7,23*
Shooting Star (B6)	Frequency	1003									
	Mean rate of return	0,08%	0,06%	-0,01%	-0,15%	-0,08%	-0,14%	-0,08%	-0,05%	0,02%	0,03%
	t-value	1,24	0,59	-0,05	-0,95	-0,44	-0,69	-0,38	-0,22	0,08	0,13
	Frequency (sl)	1003	971	906	835	785	751	715	677	642	622
	Mean of return (sl)	0,11%	0,33%	0,65%	1,10%	1,58%	1,92%	2,26%	2,66%	3,14%	3,45%
	t-value (sl)	1,78*	3,56*	5,90*	8,80*	11,02*	11,98*	12,79*	14,14*	15,65*	15,70*

Note: "sl" = stop loss; "*" denotes significant rejection of hypothesis in one tail at the 5% significance level.

Appendix C: t-Tests of mean rates of return for each candlestick on each holding day (continued)

Candlesticks		Holding days									
		1	2	3	4	5	6	7	8	9	10
Panel C: Bullish reversal patterns											
Hammer (C1)	Frequency	13									
	Mean rate of return	0,71%	-0,15%	0,38%	0,70%	0,96%	0,54%	1,09%	2,18%	2,54%	2,76%
	t-value	0,94	-0,16	0,40	0,73	0,77	0,34	0,55	0,88	1,06	0,93
	Frequency (sl)	13	13	11	11	11	11	10	10	9	9
	Mean of return (sl)	0,71%	-0,52%	1,02%	1,49%	1,91%	2,06%	3,21%	4,52%	6,20%	6,66%
	t-value (sl)	0,94	-0,50	1,08	1,67	1,54	1,42	1,52	1,62	2,37*	1,97*
Bullish (C2)	Frequency	224									
	Mean rate of return	0,01%	0,58%	0,80%	1,20%	1,14%	0,73%	1,31%	1,86%	2,13%	1,64%
	t-value	0,05	1,78*	1,92*	2,44*	2,02*	1,24	2,04*	2,72*	3,00*	2,19*
	Frequency (sl)	224	219	181	166	158	136	131	124	116	114
	Mean of return (sl)	0603%	0,77%	2,40%	3,68%	4,03%	5,17%	6,17%	7,31%	8,00%	8,04%
	t-value (sl)	0,17	2,46*	5,93*	7,70*	6,78*	8,34*	8,57*	9,04*	9,37*	9,24*
Piercing Liner (C3)	Frequency	25									
	Mean rate of return	1,56%	1,34%	0,25%	1,43%	2,58%	2,46%	3,51%	4,15%	4,32%	4,04%
	t-value	2,26*	1,32	0,19	1,05	1,50	1,12	1,64	1,81*	1,85*	1,85*
	Frequency (sl)	25	24	21	16	16	16	15	15	14	14
	Mean of return (sl)	1,63%	1,68%	1,76%	4,98%	6,52%	7,45%	9,23%	9,97%	10,91%	9,81%
	t-value (sl)	2,46*	1,74*	1,39	3,52*	3,32*	2,95*	3,77*	3,81*	3,76*	3,69*

Note: "sl" = stop loss; "*" denotes significant rejection of hypothesis in one tail at the 5% significance level.

Appendix C: t-Tests of mean rates of return for each candlestick on each holding day (continued)

Candlesticks		Holding days									
		1	2	3	4	5	6	7	8	9	10
Panel C: Bullish reversal patterns											
Bullish Harami (C4)	Frequency	28									
	Mean rate of return	-0,36%	0,37%	1,34%	2,35%	2,33%	3,15%	3,70%	4,35%	4,62%	5,38%
	t-value	-0,79	0,48	1,32	1,97*	2,03*	2,35*	2,55*	3,13*	2,94*	3,07*
	Frequency (sl)	28	28	22	21	21	19	17	16	16	16
	Mean of return (sl)	-0,36%	0,11%	2,65%	4,26%	3,56%	5,46%	7,08%	8,14%	8,84%	9,99%
	t-value (sl)	-0,79	0,13	2,40*	3,49*	2,67*	3,46*	3,96*	4,82*	4,67*	4,36*
Three Inside Up (C5)	Frequency	6									
	Mean rate of return	0,53%	2,96%	3,78%	2,48%	5,77%	6,53%	5,32%	4,14%	4,70%	3,23%
	t-value	0,33	1,06	2,13*	2,31*	3,73*	3,71*	2,49*	2,46*	2,87*	1,53
	Frequency (sl)	6	6	5	5	5	5	5	5	5	5
	Mean of return (sl)	0,53%	2,87%	4,71%	2,26%	5,68%	6,95%	5,68%	4,44%	3,68%	1,38%
	t-value (sl)	0,33	1,01	2,55*	1,75	3,00*	3,31*	2,20*	2,19*	2,35*	0,78
Three Outside Up (C6)	Frequency	19									
	Mean rate of return	1,75%	1,54%	2,23%	2,42%	0,87%	1,81%	2,80%	3,89%	4,03%	5,06%
	t-value	2,07*	1,53	1,33	1,45	0,56	1,17	2,21*	2,57*	2,10*	2,76*
	Frequency (sl)	19	17	16	13	12	12	12	12	12	11
	Mean of return (sl)	1,75%	2,26%	3,81%	4,94%	4,36%	4,82%	4,63%	5,61%	5,86%	6,68%
	t-value (sl)	2,06*	2,40*	2,35*	2,58*	3,67*	3,20*	3,16*	2,60*	2,25*	2,54
Tweezer Bottom (C7)	Frequency	34									
	Mean rate of return	-0,83%	0,53%	1,33%	1,18%	1,10%	0,95%	1,35%	0,62%	0,52%	0,39%
	t-value	-2,07*	1,53	1,33	1,45	0,56	1,17	2,21*	2,57*	2,10*	2,76*
	Frequency (sl)	34	32	29	27	26	24	24	23	23	22
	Mean of return (sl)	-0,79%	0,65%	1,98%	2,10%	2,28%	2,69%	3,10%	2,75%	2,81%	3,48%
	t-value (sl)	-2,04	0,94	2,28*	2,51*	2,38*	2,63*	2,44*	2,31*	1,99*	1,98*

Note: "sl" = stop loss; "*" denotes significant rejection of hypothesis in one tail at the 5% significance level.

Appendix C: t-Tests of mean rates of return for each candlestick on each holding day (continued)

Candlesticks		Holding days									
		1	2	3	4	5	6	7	8	9	10
Panel D: Bearish reversal patterns											
Hanging Man (D1)	Frequency	36									
	Mean rate of return	-0,39%	-0,50%	-0,54%	-1,38%	-1,76%	-2,37%	-3,10%	-3,09%	-3,32%	-2,98%
	t-value	-1,18	-0,96	-0,71	-1,82	-2,06	-2,24	-2,56	-2,52	-2,32	-2,23
	Frequency (sl)	36	35	31	30	30	27	26	22	21	20
	Mean of return (sl)	-0,32%	-0,29%	0,67%	0,17%	-0,29%	-0,08%	-0,30%	0,53%	0,91%	1,17%
	t-value (sl)	-1,10	-0,67	1,25	0,35	-0,45	-0,11	-0,39	0,59	0,80	1,19
Bearish Engulfing (D2)	Frequency	295									
	Mean rate of return	0,32%	0,23%	0,11%	-0,08%	-0,59%	-0,88%	-1,64%	-1,98%	-2,19%	-2,50%
	t-value	2,13*	0,96	0,33	-0,23	-1,41	-2,02	-3,22	-3,63	-3,87	-4,06
	Frequency (sl)	295	285	242	212	195	175	156	141	133	129
	Mean of return (sl)	0,34%	0,38%	1,36%	2,10%	2,38%	2,52%	3,12%	3,65%	4,05%	4,30%
	t-value (sl)	2,24*	1,70*	4,86*	7,18*	6,86*	6,39*	6,91*	7,71*	8,04*	7,53*
Dark Cloud Cover (D3)	Frequency	44									
	Mean rate of return	0,96%	1,10%	2,02%	2,34%	3,01%	2,49%	2,31%	2,79%	2,58%	2,13%
	t-value	2,25*	1,66	2,45*	3,10*	3,98*	2,56*	2,21*	2,36*	1,92*	1,77*
	Frequency (sl)	44	42	38	36	35	34	34	31	25	24
	Mean of return (sl)	0,93%	1,54%	3,31%	3,48%	3,86%	3,49%	3,36%	4,08%	6,21%	5,90%
	t-value (sl)	2,14*	2,55*	4,72*	5,23*	5,49*	3,92*	3,56*	3,63*	5,21*	5,15*

Note: "sl" = stop loss; "*" denotes significant rejection of hypothesis in one tail at the 5% significance level.

Appendix C: t-Tests of mean rates of return for each candlestick on each holding day (continued)

Candlesticks		Holding days									
		1	2	3	4	5	6	7	8	9	10
Panel C: Bearish reversal patterns											
Bearish Harami (D4)	Frequency	16									
	Mean rate of return	1,14%	1,72%	0,20%	-0,53%	0,07%	-1,24%	0,01%	-1,01%	-1,39%	-2,30%
	t-value	1,60	1,48	0,15	-0,29	0,04	-0,58	0,01	-0,43	-0,54	-0,78
	Frequency (sl)	16	16	15	13	11	10	9	9	7	7
	Mean of return (sl)	1,14%	1,97%	0,87%	1,78%	3,72%	3,37%	4,12%	3,72%	6,84%	7,11%
	t-value (sl)	1,60	1,92*	0,72	1,13	2,18*	2,33*	2,14*	1,37	2,05*	2,00*
Three Inside Down (D5)	Frequency	19									
	Mean rate of return	-0,30%	-0,39%	1,47%	1,00%	0,71%	0,04%	-0,35%	-0,39%	-0,32%	-0,91%
	t-value	-0,40	-0,50	1,22	0,72	0,42	0,02	-0,17	-0,20	-0,14	-0,37
	Frequency (sl)	19	16	14	12	11	11	9	8	8	8
	Mean of return (sl)	-0,28%	-0,21%	2,14%	2,19%	3,64%	2,44%	4,42%	4,73%	5,31%	5,96%
	t-value (sl)	-0,39	-0,25	1,64	1,63	2,58*	1,31	2,23*	2,50*	3,26*	3,45*
Three Outside Down (D6)	Frequency	18									
	Mean rate of return	0,97%	1,54%	1,65%	1,67%	-0,31%	-0,56%	-0,71%	-0,85%	-1,39%	-2,29%
	t-value	1,65	1,56	2,06*	1,48	-0,20	-0,31	-0,33	-0,37	-0,56	-0,95
	Frequency (sl)	18	18	18	17	14	12	12	12	12	11
	Mean of return (sl)	0,97%	1,54%	1,43%	1,85%	1,41%	3,90%	4,07%	3,40%	3,30%	2,86%
	t-value (sl)	1,65	1,56	1,64	1,55	0,87	2,89*	2,37*	2,12*	2,12*	2,04*
Tweezer Top (D7)	Frequency	44									
	Mean rate of return	-0,39%	0,07%	-0,38%	-2,13%	-2,75%	-3,59%	-3,81%	-4,14%	-3,40%	-3,49%
	t-value	-0,84	0,11	-0,47	-2,22	-2,44	-2,69	-2,68	-2,73	-2,57	-2,57
	Frequency (sl)	44	38	34	30	28	24	22	21	21	20
	Mean of return (sl)	-0,28%	0,75%	1,27%	0,90%	1,31%	2,51%	2,77%	3,04%	3,03%	3,43%
	t-value (sl)	-0,66	1,24	1,62	1,12	1,34	2,50*	2,63*	2,79*	2,88*	3,38*

Note: "sl" = stop loss; "*" denotes significant rejection of hypothesis in one tail at the 5% significance level.